

nifty

Heightrider

Operating & Safety Instructions

**MODEL HR10 (SP26), HR12 (SP34)
& HR12 4x4 (SP34 4x4) SERIES**

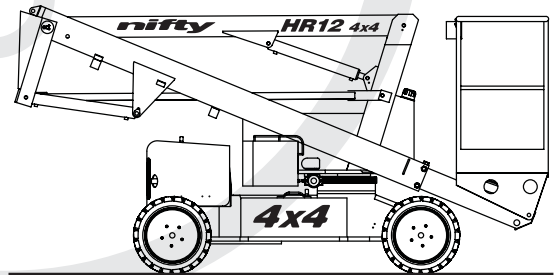
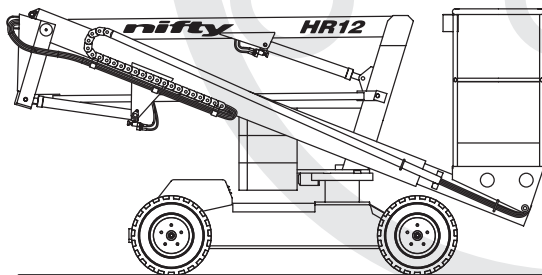
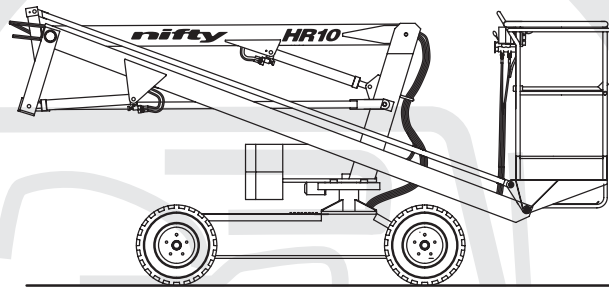

Manufactured by:
Niftylift Limited
Fingle Drive
Stonebridge
Milton Keynes
MK13 0ER
England

www.niftylift.com
e-mail: info@niftylift.com
Tel: +44 (0)1908 223456
Fax: +44 (0)1908 312733



niftylift.com
info@niftylift.com



Table of Contents

1	INTRODUCTION AND GENERAL INFORMATION	PAGE
1.1	Foreword	2
1.2	Scope	3
1.3	Introducing the “Height Rider” Self Propelled (SP) Series	3
1.4	General Specification	4
1.5	Identification	5-6
2	SAFETY	
2.1	Mandatory Precautions	7-10
2.2	Environmental Limitations	10
2.3	Noise & Vibration	10
3	PREPARATION AND INSPECTION	
3.1	Unpacking	11
3.2	Preparation for Use	11
3.3	Pre-Operational Safety Check Schedules	12-13
3.4	Placard, Decals and Installation	14-17
3.5	Torque Requirements	18
4	OPERATION	
4.1	Control Circuit Components	19-21
4.2	Ground Control Operation	22-23
4.3	Platform Control Operation	24-25
4.4	Drive Control Operation	26
4.5	Cage Weigh System	27-29
4.6	Batteries and Charging	30-31
4.7	Transporting, Towing, Craneage, Storage and Setting to Work	32-36
5	EMERGENCY CONTROLS	
5.1	General	37
5.2	Emergency Procedures - Incapacitated Operator	37
5.3	Emergency Procedures - Machine Failure	37
5.4	Incident Notification	37
6	RESPONSIBILITIES	
6.1	Changes in Ownership	38
6.2	Manual of Responsibilities (USA only)	38
6.3	Inspection/ Service Check List	39-40

1 Introduction and General Information

1.1 FOREWORD

The purpose of these manuals is to provide the customer with appropriate safety operating and maintenance instructions essential for proper machine operation.

All information in these manuals should be **READ** and fully **UNDERSTOOD** before any attempt is made to operate the machine. **THESE MANUALS ARE VERY IMPORTANT TOOLS** - Keep them with the machine at all times.

The manufacturer has no direct control over machine application and use, therefore conformance with good safety practices is the responsibility of the user and his operating personnel.

All information in these manuals is based on the use of the machine under proper operating conditions. Alteration and/or modification of the machine are strictly forbidden.

One of the most important facts to remember is that any equipment is only as safe as those who operate it.

DANGER, WARNING, CAUTION, IMPORTANT, INSTRUCTIONS AND NOTICE

Any place these topics may appear, either in this manual or on the machine, they are defined as follows:

DANGER: If not correctly followed there is a high probability of serious injury or death to personnel.

WARNING OR CAUTION: If not correctly followed there is some possibility of serious injury or death to personnel.



THE '**SAFETY ALERT**' SYMBOL IS USED TO CALL ATTENTION TO POTENTIAL HAZARDS THAT MAY LEAD TO SERIOUS INJURY OR DEATH, IF IGNORED.

IMPORTANT AND INSTRUCTIONS: Denotes procedures essential to safe operation and prevention of damage to or destruction of the machine.

NOTICE: Indicates general safety rules and/or procedures relating to the machine.

It is the owner's/user's responsibility to know and comply with all applicable rules, regulations, laws, codes and any other requirements applicable to the safe use of this equipment.

1.2 SCOPE

These operating instructions contain all the necessary information required to allow the safe operation of any Niftylift Height Rider, HR10 or HR12 (SP26 or SP34), powered by electric (DC), diesel (D), petrol/gasoline (P) engine, or a combination of these.

For further technical information, circuit diagrams and specific instructions for all maintenance which may need to be carried out by specialist trained personnel, see the associated Workshop and Parts manual for your model of Niftylift Height Rider.

1.3 INTRODUCING THE HEIGHT RIDER SELF-PROPELLED (SP) SERIES

Please note at the time of going to press all information, illustrations, details and descriptions contained herein are valid. Niftylift reserves the right to change, modify or improve its products without any obligations to install them on previously manufactured machines.

If you require further information after reading this manual, please do not hesitate to contact us.

Niftylift Ltd, Fingle Drive, Stonebridge, Milton Keynes MK13 0ER, Great Britain

Tel: +44 (0) 1908 223456 Fax: +44 (0) 1908 312733

Niftylift Inc, 32 Concourse Way, Greer, SC 29651 USA

Tel: +01 864 968 8881 Fax: +01 864 968 8836

Nifty Pty Ltd, 265 King Street, Newcastle, NSW 2300, Australia

Tel: +61 (0) 2 4929 6700 Fax: +61 (0) 2 4925 2570

Driven from the platform, the Niftylift Height Rider is an extremely versatile articulated boom platform of unique and simple design. It is capable of placing two men and their tools up to a height of 12.20m (40ft) or an outreach of 6.10m (20ft 1in).

The booms are mounted via a 360° powered swing mechanism onto a compact narrow base with a tight turning circle that ensures excellent manoeuvrability and maximum efficiency.

High traction tyres and powerful hydraulic wheel motors give unsurpassed performance with the option of fast drive speed when the booms are in the stowed position. Automatic braking and audible alarms activated by a five-degree tilt sensor help to prevent the operator from working on unsafe terrain whilst elevated.

A simple, all-hydraulic proportional control system gives smooth, reliable movement of the platform and maximum reliability in the harshest environments.

Models include the following:

E: - DC ELECTRIC

BE: - BI-ENERGY (DIESEL & BATTERY)

D: - DIESEL

PE: - PETROL & BATTERY

P: - PETROL

PG: - PETROL & LPG (PROPANE)

A: - AIR

T: - TRI - ENERGY (PETROL, PROPANE & BATTERY)

nifty Height Rider/SP Series

Operating & Safety Instructions

1.4 GENERAL SPECIFICATION

FEATURE	HR10	HR10N	HR12	HR12N	HR12 4x4
MAXIMUM HEIGHT - WORKING	10m 33ft		12.20m 40ft		12.25m 40ft 2in
MAXIMUM HEIGHT - PLATFORM	8m 26ft		10.20m 33ft 6in		10.25m 33ft 8in
MAXIMUM OUTREACH	4.50m 14ft 9in		6.10m 20ft 6in		
MAXIMUM HEIGHT – STOWED	1.90m 6ft 3in				1.94m 6ft 4in
MAXIMUM WIDTH	1.50m 4ft 11in	1.40m 4ft 7in	1.80m 5ft 10in	1.50m 4ft 11in	1.62m 5ft 4in
MAXIMUM LENGTH – STOWED	4.30m 14ft		4.10m 13ft 5in		3.98m 13ft 1in
PLATFORM CAPACITY (USA)	200kg (440lbs) 500lbs				
WHEELBASE	1.80m 5ft 11in				
TURNING RADIUS – OUTSIDE	3.15m 10ft 6in				3.4m 11ft 2in
TURRET ROTATION	355°				
TURRET TAILSWING	Zero				
TRAVEL SPEED – STOWED	0-2.1mph 0-3.4kph				0-2.3mph 0-3.7kph
PLATFORM SIZE	0.65m x 1.10m 25in x 44in				
CONTROLS	Fully Proportional Hydraulic				
HYDRAULIC PRESSURE	200bar				
TYRES	Foam Filled				
GRADE-ABILITY	25%				30%
GROUND CLEARANCE	165mm 6.5in		185mm 7.25in		260mm 10.24in
MINIMUM VEHICLE WEIGHT	1930kg 4255lb	1250kg 4740lb	2400kg 5285lb	2950kg 6490lb	3330kg 7340lbs
MAXIMUM GROUND PRESSURE	0.049kn/cm ² 10208lb/ft ²	0.054kn/cm ² 11250lb/ft ²	0.040kn/cm ² 8333lb/ft ²	0.048kn/cm ² 10000 lb/ft ²	0.054kn/ cm ² 11290lb/ft ²
POWER SOURCE	E (Electric) models - 4 x 6v 250 AH batteries P (G) (Petrol/Gasoline) models - Honda GX240 Engine D (Diesel) models - Kubota OC60 or OC95 engine (D482 – 4x4 Version)				

1.5 IDENTIFICATION (UK PLATE)

			
NIFTYLIFT LTD. FINGLE DRIVE, STONEBRIDGE MILTON KEYNES MK13 0ER ENGLAND TEL 01908 223456 : FAX 01908 312733 e-mail : info@niftylift.com			
SERIAL No			
TYPE			
YEAR OF MANUFACTURE			
WEIGHT			kg
RATED LOAD	PERSONS	+	kg
MAXIMUM SAFE WORKING LOAD			kg
MAXIMUM PULL			N
MAXIMUM WIND SPEED			m/s
MAX. ALLOWABLE INCLINATION			Deg.
MAXIMUM HYDRAULIC PRESSURE			bar
MAXIMUM VOLTAGE			V
AMPS			A
ELEC. CCT D		ISSUE	
HYD. CCT D		ISSUE	
			P10805

This manufacturer's plate is attached to Boom 1 on each machine at the time of manufacture on every Niftylift. Please ensure all sections have been stamped and are legible.

1.5a IDENTIFICATION (USA PLATE)

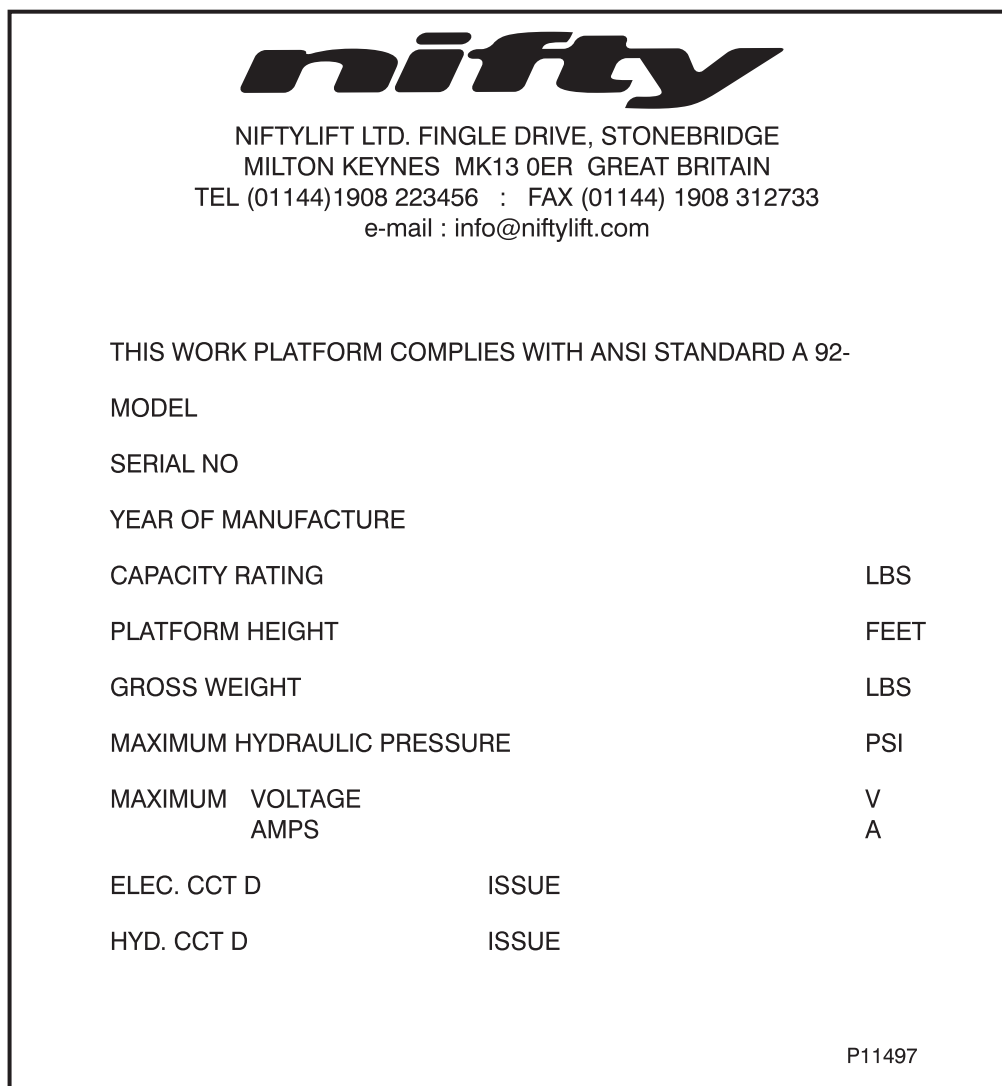

This manufacturer's plate is attached to Boom 1 on each machine at the time of manufacture on every Niftylift. Please ensure all sections have been stamped and are legible.

2 Safety

2.1 MANDATORY PRECAUTIONS

When operating your Niftylift, your safety is of utmost concern. In order to fully appreciate all aspects of the machines operation it should be ensured that each operator has **READ** and fully **UNDERSTOOD** the relevant manual covering machine use, maintenance and servicing. If any doubts exist concerning any points covered in your manual, contact your local dealer or Niftylift Ltd.

Before using any Niftylift, thoroughly inspect the machine for damage or deformation to all major components. Likewise, check the control systems for hydraulic leaks, damaged hoses, cable faults or loose covers to electrical components. At no time should damaged or faulty equipment be used - Correct all defects before putting the platform to work. If in doubt, contact your local dealer or Niftylift Ltd (see front cover for address).



THE MANUFACTURER HAS NO DIRECT CONTROL OVER THE MACHINE APPLICATION AND USE. THEREFORE CONFORMANCE WITH GOOD SAFETY PRACTICES IS THE RESPONSIBILITY OF THE USER AND HIS OPERATING PERSONNEL. FAILURE TO UNDERSTAND AND FOLLOW ALL SAFETY RULES COULD RESULT IN SERIOUS INJURY OR DEATH.

- 2.1.1** Only trained persons will be permitted to operate the Niftylift.
- 2.1.2** Always operate the Niftylift in full accordance with the manufacturers Operating & Safety Instructions for that model.
- 2.1.3** Before use each day and at the beginning of each shift the Niftylift shall be given a visual inspection and functional test including, but not limited to, operating and emergency controls, safety devices, personal protective clothing, including fall protection, air, hydraulic and fuel system leaks, cables and wiring harness, loose or missing parts, tyres and wheels, placards, warnings, control markings and Operating and Safety Manuals, guards and guard rail systems and all other items specified by the manufacturer.
- 2.1.4** Any problems or malfunctions that affect the safety of operations shall be repaired prior to the use of the Niftylift.
- 2.1.5** Always ensure that all warning labels, instructions, placards, control markings and Safety Manuals are intact and clearly legible. If replacements are required contact your local dealer or Niftylift. Always observe and obey safety and operating instructions on such labels.
- 2.1.6** Do not alter, modify or disable in any way the controls, safety devices, interlocks or any other part of the machine.
- 2.1.7** Before the Niftylift is used and during use the user shall check the area in which it is to be used for possible hazards such as, but not limited to, uneven ground drop-offs, holes, bumps, obstructions, debris, floor and overhead obstructions, high voltage conductors, wind and weather, unauthorised persons and any other possibly hazardous conditions.

Operating & Safety Instructions

2.1.8 Never exceed the maximum platform capacity, as indicated on the decals and machine serial plate.

2.1.9 Only operate the Niftylift on a firm, level surface.

2.1.10 Never position any part of the Niftylift within 4.0m, (12ft) of any electrical power line, conductor or similar not exceeding 66kV. (Minimum span 125m) Other distances for increased voltages and different spans are given in NZECP 34:1993.



THIS MACHINE IS NOT INSULATED

If in doubt, contact the appropriate authorities.

2.1.11 On entering the platform, ensure that the drop down entry bar is closed afterwards.

2.1.12 Use of an approved safety belt and lanyard, hard hat and appropriate safety clothing is mandatory. Fasten harness to designated harness securing points within the platform and do not remove until leaving the platform whilst in the stowed position.

2.1.13



Always remain standing within the platform. Do not attempt to increase your height or reach by standing and/or climbing on the platform guard rails or any other object. **KEEP YOUR FEET ON THE PLATFORM FLOOR.** Do not sit, stand or climb on the guard rail, mid rail or boom linkage. Use of planks, ladders or any other devices on the Niftylift for achieving additional height or reach shall be prohibited.

2.1.14 Do not use the platform levelling system to artificially increase the outreach of the platform. Never use boards or ladders in the platform to achieve the same result.

2.1.15 Do not use the platform to lift overhanging or bulky items that may exceed the maximum capacity or carry objects that may increase the wind loading on the platform. (e.g. Notice boards etc.)

2.1.16 The Niftylift shall not be operated from a position on trucks, trailers, railway cars, floating vessels, scaffolds or similar equipment unless the application is approved in writing by Niftylift Ltd in Great Britain.

2.1.17 Always check that the area below and around the platform is clear of personnel and obstructions before lowering or slewing. Care should be taken when slewing out into areas where there may be passing traffic. Use barriers to control traffic flow or prevent access to the machine.

Important:- To prevent damage to the cage step, it is necessary to elevate the booms a minimum of **250mm** (10 in) from their stowed position **before** slewing. Also, when lowering the booms down to their stowed height, check that the cage step is not directly above any wheel to prevent damage to the step, similarly check that the booms are clear of the front canopy to prevent damage.

2.1.18 Stunt driving and horseplay, on or around the Niftylift, shall not be permitted.

2.1.19 When other moving equipment and vehicles are present, special precautions shall be taken to comply with local ordinances or safety standards established for the work place. Warnings such as, but not limited to, flags, roped off areas, flashing lights and barricades shall be used.

- 2.1.20** Before and during driving while the platform is elevated the operator shall maintain a clear view of the path of travel, maintain a safe distance from obstacles, debris, drop offs, holes, depressions, ramps and other hazards to ensure safe elevated travel. Maintain a safe distance from overhead obstacles.
- 2.1.21** Under all travel conditions the operator shall limit travel speed according to conditions of ground surface, congestion, visibility, slope, location of personnel and other factors causing hazards of collision or injury to personnel.
- 2.1.22** The aerial platform shall not be driven on grades, side slopes or ramps exceeding those for which the aerial platform is rated by the manufacturer.
- 2.1.23** It shall be the responsibility of the user to determine the hazard classification of any particular atmosphere or location. Aerial platforms operated in hazardous locations shall be approved and suitable for the duty. (See ANSI/NFPA 505-1987 where applicable).
- 2.1.24** The operator shall immediately report to his supervisor any potentially hazardous location(s) (environment) which become evident during operation.
- 2.1.25** If an operator encounters any suspected malfunction of the Niftylift or any hazard or potentially unsafe condition relating to capacity, intended use or safe operation, he shall cease operation of the Niftylift and request further information as to safe operation from his management, or owner, dealer or manufacturer before further operation of the Niftylift.
- 2.1.26** The operator shall immediately report to his superior any problems or malfunctions of the Niftylift, which becomes evident during operation. Any problems or malfunctions that affect the safety of operation shall be repaired prior to continued use.
- 2.1.27** The boom and platform of the Niftylift shall not be used to jack the wheels off the ground.
- 2.1.28** The Niftylift shall not be used as a crane.
- 2.1.29** The Niftylift shall not be positioned against another object to steady the platform.
- 2.1.30** Care should be taken to prevent rope, electric cords and hoses from becoming entangled in the aerial platform.
- 2.1.31** Batteries shall be recharged in a well-ventilated area free of flame, sparks or other hazards, which may cause explosion. Highly explosive hydrogen gas is produced during the charging process.
- 2.1.32** When checking electrolyte levels great care should be taken to protect eyes, skin and clothing. Battery acid is highly corrosive and protective glasses and clothing is recommended.
- 2.1.33** If the platform or elevating assembly becomes caught, snagged or otherwise prevented from normal motion by adjacent structure or other obstacles, such that control reversal does not free the platform, all personnel shall be removed from the platform safely before attempts are made to free the platform using ground controls.

2.1.34

When the machine is not in use always stow the booms correctly. **NEVER LEAVE THE KEYS IN THE MACHINE**, if it is to be left for any period of time. Use wheel chocks if leaving on an incline.

Operating & Safety Instructions

2.1.35 The engine must be shut down while fuel tanks are being filled. Fuelling must be done in a well-ventilated area free of flame, sparks or any other hazard that may cause fire or explosion. **PETROL (GASOLINE), LIQUID PROPANE AND DIESEL FUELS ARE FLAMMABLE.**

2.1.36



NEVER START THE NIFTYLIFT IF YOU SMELL (PETROL) GASOLINE, LIQUID PROPANE OR DIESEL FUEL.THESE FUELS ARE HIGHLY FLAMMABLE

2.1.37 The operator shall implement means provided to protect against use by unauthorised persons.

2.1.38 Never remove anything that may affect the stability of the machine such as, but not limited to, batteries, covers, engines, tyres or ballast.

2.2 ENVIRONMENTAL LIMITATIONS

All "Niftylift" Height Riders are limited to operation as previously described, not suitable for rough terrain work. Unless specifically configured otherwise, the machine will have short time rating for operation in extreme temperatures. i.e. Reduced battery cycle times for low temperatures, e.g. freezers, food storage etc., cooling limitations for high temperatures. i.e. oil temperature not to exceed -23 to 93° Celsius. Extended operation in dusty environments is not recommended, frequent cleaning will be necessary. All dust, dirt, salt encrustation, excess oil or grease should be removed. Deposits of paint or bitumen, particularly on legends or labels should be removed.

All standard Niftylift machines are rated for a wind speed of 12.5 m/s, which equates to 45kph / 28mph or force 6 on the Beaufort scale. No attempt should be made to operate a Niftylift in wind strengths above this limit and if the operator has any doubts over the wind speed he /she should cease operation immediately until it can be established that the wind speed has fallen to a safe level.



DO NOT USE THE NIFTYLIFT IN ELECTRICAL STORMS

2.3 NOISE AND VIBRATION

The airborne noise emission on the Height Rider range of machines does not exceed 79dB(A), measured at a perpendicular distance of 4m, under equivalent continuous A-weighted sound pressure test conditions. This was based on a Diesel powered machine, working on high throttle, and under load. All other models will exhibit significantly lower emissions than this figure, dependant on power option. In normal operation the Vibration level to which the operator is subjected will not exceed a weighted root mean square acceleration value of 2.5 m/s².

3 Preparation and Inspection

3.1 UNPACKING

Since the manufacturer has no direct control over the shipping or carriage of any Niftylift it is the responsibility of the dealer and/or owner and/or leaser to ensure the Niftylift has not been damaged in transit and a Pre-operational Report has been carried out by a qualified engineer before the aerial platform is put into service.

- A) Remove all ropes, straps and or chains used to secure the aerial platform during transit.
- B) Ensure any ramp, loading dock or forklift used is capable of supporting or lifting the aerial platform.
- C) If the aerial platform is to be driven off, please ensure that the operator has read and fully understood this entire manual. Refer to the appropriate section for precise operating instructions.

*****Carry out the Pre-operational Report before placing machine in service.**

3.2 PREPARATION FOR USE

Whilst every effort has been made at the Niftylift factory to ensure your machine arrives in a safe and operable condition it is necessary to carry out a systematic inspection prior to putting the aerial platform into service.



THIS IS NOT A REQUEST IT IS MANDATORY

To assist the user in this task you will find enclosed a Pre-operational Report, which must be filled out upon delivery/receipt of the machine.

Before the user carries out the Pre-operational Report he must have read and fully understood all the contents of the Operating, Safety and Maintenance Manual.



WARNING - DO NOT OPERATE A POTENTIALLY DEFECTIVE OR MALFUNCTIONING MACHINE. CORRECT AND REPAIR ANY DEFECTS BEFORE OPERATING YOUR NIFTYLIFT.

Operating & Safety Instructions

3.3 PRE-OPERATIONAL SAFETY CHECK SCHEDULES

Before use each day and at the beginning of each shift the aerial platform shall be given a visual inspection and functional test including, but not limited to, the following:

3.3.1 DAILY SAFETY CHECKS

- 1) Check that all labels (decals) are in place and legible.
- 2) Visually inspect the machine for damaged or loose components.
- 3) Check that batteries are charged (i.e. Charger has a solid green light and a pulsing red light).
- 4) Check the fuel level (if applicable).
- 5) Check that canopies/covers and guards are in place and secure.
- 6) Check that the boom rest switch is operable (if applicable).
- 7) Check that control levers are secure and operate freely.
- 8) Check that operating buttons and emergency stop buttons function properly.
- 9) Check the operation of the emergency hand pump.
- 10) Visually inspect all hydraulic hoses and fittings for damage or leaks.
- 11) Check that the platform pivot pins and their tag bolts are secure.
- 12) Check that the tilt alarm is functioning properly (On a slope of 5° or more the alarm should sound and drive should be disabled)
- 13) Check the operation of the cage weigh system (If fitted). See section 4.5.3 for testing and verification procedure.

3.3.2 WEEKLY SAFETY CHECKS

- 1) Inspect tyres and wheels for damage and wear.
- 2) Check that the joystick manipulators are secure.
- 3) Check battery fluid levels and specific gravity (after charging) and general condition.
- 4) Check hydraulic oil level (ISO Grade 22).
- 5) Inspect the engine air filter and clean or replace if necessary.
- 6) Inspect hose track for damage or missing parts.

3.3.3 MONTHLY SAFETY CHECKS

- 1) Check the engine oil level (if applicable).
- 2) Check the wheel nuts (torque 65ft lbs / 86Nm).
- 3) Check that the bolts holding the wheel motors to the chassis are secure.
- 4) Check that the slew worm is secured and correctly in mesh. Clean and re-grease.
- 5) Inspect brakes for operation and wear.
- 6) Grease the knuckle and centre post.
- 7) Inspect the engine fuel tank for damage or leaks.
- 8) Check telescopic boom wear pads and nylon studs (if applicable).
- 9) Check that the end cap on the main knuckle pin is secure and the roll pin is in place.
- 10) Check and adjust if necessary the Nylatron studs around the telescope boom.
- 11) Every **three** months check and verify the calibration of the cage weigh system. See section 4.5.4 for the calibration procedure.
- 12) Every **Six** months perform a **thorough examination** in accordance with the 'Lifting Operation and Lifting Equipment Regulations' (LOLER) 1998, Regulation (9)(3)(a).

3.3.4 ANNUAL SAFETY CHECKS

- 1) Check that all pivot pins and their tag bolts are secure.
- 2) Inspect for any cracks or badly rusted areas on booms and chassis.
- 3) Change the hydraulic oil filters.
- 4) Check the bushes in the front wheel hubs for wear.
- 5) Check that slew ring bolts are secure (torque 206ft lbs. 279Nm).

Operating & Safety Instructions**3.4 PLACARD, DECALS & INSTALLATION (UK SPEC)**

ITEM	DESCRIPTION	NUMBER	QTY	
1	SWL 200kg	P14801	1	
2	Harness Point	P14883	2	
4	General Notice	P18870	1	
5	Blank Serial Plate	P15383	1	
6	Daily Safety Check List	P14908	1	
7	Trip – Push to Reset	P19056	1	
8	Travel Direction	P14784	2	
9	If Alarm Sounds...	P14868	2	
10	E-Stop, Do Not Disable	P14864	2	
11	Head Protection	P14921	1	
12	Emergency Hand Pump	P12402	1	
13	Component Stability	P19708	1	
14	“Nifty HR12” – Grey	P14604	2	
15	“Niftylift.com” – Black	P14390	1	
16	“Height Rider 12” – Grey	P14605	1	
17	General Warning	P18672	2	
18	Booms / Brakes Selector	P19446	1	
19	Foam Filled Tyres	P14932	1	
20	Drive Wheel Lock	P19444	1	
21	Base/Cage selector	P19445	1	
22	No Step	P14785	1	
23	Cage Levelling	P10853	1	
25	Point Load	16.7kN (2x4) 20.8kN (4x4)	P20607 P20634	4 4
26	Battery Management	P11777	1	
28	Battery Isolator	P18610	1	
29	Battery Charger	P14904	1	
31	Diesel	P14414	1	
32	Point Load	19.2kN (Narrow)	P20608	4
33	Hydraulic Levers - Cage	P14939	1	
34	Hydraulic Levers - Base	P14936	1	
35	Cage Gate Warning	P18432	1	
36	Cage Controls	P18961	1	
38	Base Controls	P15221	1	
39	Noise Warning	P17124	1	
40	Operators Manual	P14892	1	
42	Overload Warning	P18848	2	
43	Trip – Push to Reset	P19056	1	
46	No Step	P14785	2	

nifty Height Rider/SP Series

Operating & Safety Instructions

nifty

HR12 Series

47	Footswitch	P14884	1
48	4x4	P14697	2
49	Battery Isolator (4x4)	P18600	1
50	Brake Release (4x4)	P18788	1

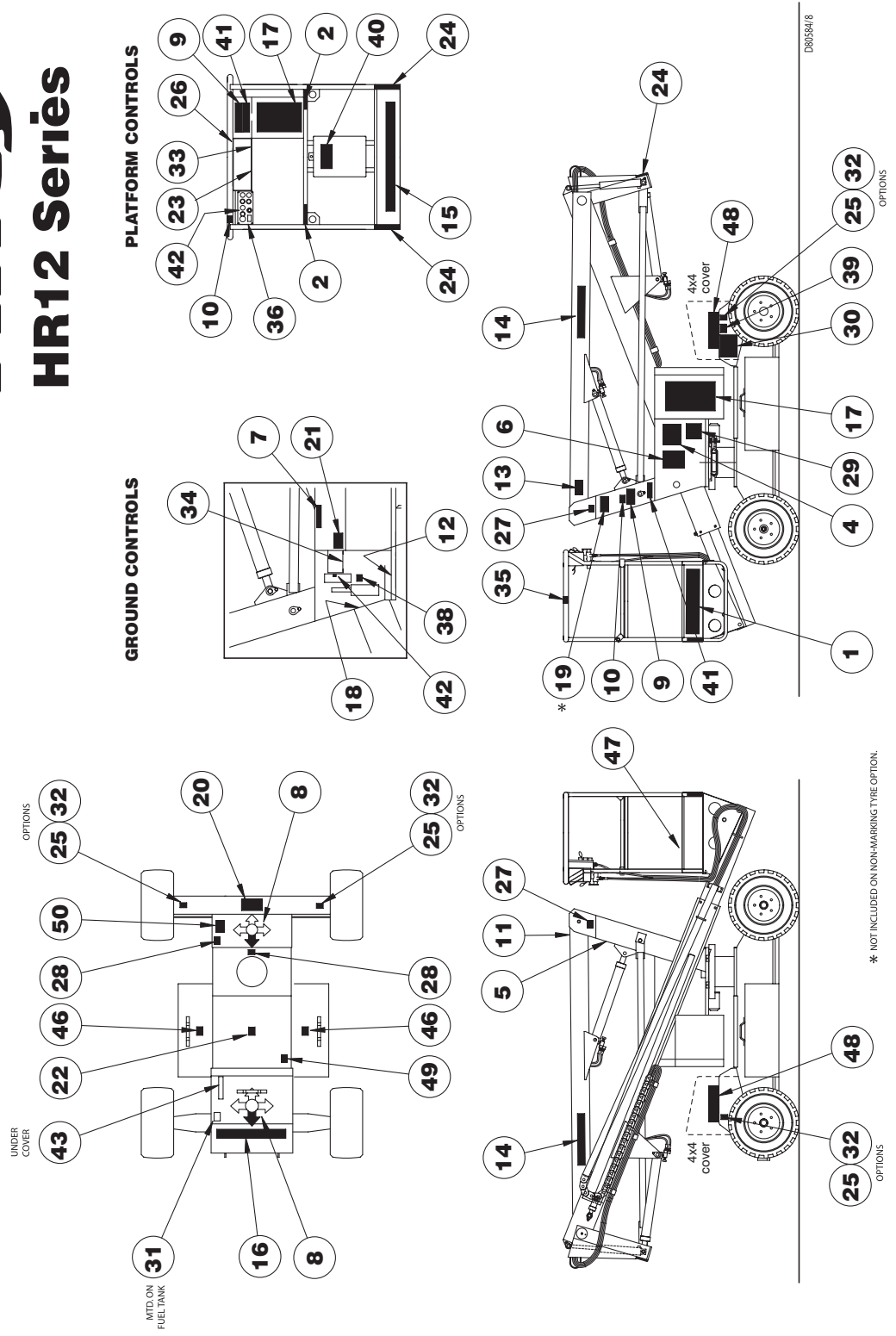

D80364/8

* NOT INCLUDED ON NON-MARKING TYRE OPTION.

nifty Height Rider/SP Series

Operating & Safety Instructions

3.4a PLACARD, DECALS & INSTALLATION (USA SPEC)

ITEM	QTY- SP26	QTY- SP33	DESCRIPTION	NUMBER
01	1	1	SWL 500 lbs	P17328
02	2	2	Harness Points	P14883
04	4	4	General Notice	P18870
05	1	1	Serial Plate	P15383
06	2	2	Rotating Machinery	P15010
07	1	1	Trip – Push to reset	P19056
08	2	2	Travel Direction Arrows	P14784
09	2	2	Tilt Alarm	P14868
10	2	2	E-Stop Disable	P14864
11	1	1	Head Protection	P14921
12	1	1	Emergency Hand Pump	P12402
13	1	1	Component Stability	P19708
14	2	0	'Niftylift' Logo (SP26)	P14117/18/14615
14	0	2	'Niftylift' Logo (SP 34)	P14119/20/14616
15	1	1	Niftylift.com	P14390
17	2	2	General Warning	P18672
18	1	1	Booms/Brake Lever	P19446
19	1	1	Foam Filled Tires	P14932
20	1	1	Wheel Release	P19444
21	1	1	Function Selector Valve	P19445
22	5	5	No Step	P14785
23	1	1	Basket Levelling	P10853
24	A/R	A/R	Warning Stripes	N/A
25	4	0	Point Load 13.6 kN	P20606
25	0	4	Point Load 16.7 kN (2x4)	P20607
			20.8 kN (4x4)	P20634
26	1	1	Battery Management	P11777
28	1	1	Battery Isolator	P18610
29	1	1	Battery Charger	P14904
31	1	1	Diesel Fuel Only	P14414
32	0	4	Point Load 19.2 kN (Narrow)	P20608
33	1	0	Platform Levers (SP26)	P15878
33	0	1	Platform Levers (SP34)	P14939
34	1	1	Ground Levers	P14936
36	1	1	Platform Control Box	P18961
38	1	1	Ground controls	P15521
39	1	1	Noise Warning	P17124
40	1	1	Operating Instructions	P14892
41	2	2	Overload Warning	P18848
42	2	2	Overload Symbol	P17214
43	1	1	Trip – Push to reset (DE)	P19056
46	2	2	No Step	P14785

3.5 TORQUE REQUIREMENTS

SCREW QUALITY/SIZE	Tightening torque in ft lbs (Nm)		
	Grade	8.8	10.9
M 6	7.4	(10)	10 (14)
M 8	18.5	(25)	26 (35)
M 10	36	(49)	51 (69)
M 12	65	(86)	89 (120)
M 14	100	(135)	140 (190)
M 16	155	(210)	218 (295)
M 18	215	(290)	300 (405)
WHEEL NUTS	65ft lbs		86Nm
SLEW RING BOLTS	206ft lbs		279Nm

4 Operation

4.1 CONTROL CIRCUIT COMPONENTS

- 4.1.1 CONTROL BOARD:** - Situated under the rear cover, the encapsulated control board comprises a PCB. (Printed circuit board) that incorporates all of the relays to control the machines operation. The control board is common to all models, and contains functions, which might not be utilised on your particular machine. A thermal trip switch is integral to the box, which protects the control circuit and components. If power is lost, the switch can be manually reset.
- 4.1.2 TILT ALARM:** - Fitted to the top of the control board box, the tilt alarm is a solid-state sensor, which monitors the inclination of the machine. It directly controls the BRV (Brake Release Valve) and when the platform is in use, i.e. Booms are raised, if the inclination exceeds the pre-set limit, it will disable the drive to the machine and sound the alarm. In order to recover the machine, the platform operation is unaffected, allowing the operator to restore drive when the machine is stowed. It is then possible to drive back onto level ground, fully restoring machine operation.
- 4.1.3 SOUNDER:** - Situated beneath the PCB is a small electric sounder, which is used to provide an intermittent alarm whenever the machine is in operation. Pushing a green "power control" button or depressing the foot switch in the platform (if fitted) will energise this sounder. This serves to warn personnel of the operation of the machine.
- 4.1.4 KLAXON:** - Also mounted on the top of the control board box is a klaxon, which performs several functions: Firstly, it can be used as a manual alert, by pushing the "Horn" button at the platform control position. Secondly, it is this device, which sounds continuously if the tilt alarm sensor detects excessive inclination, with the booms raised. Lastly, it is linked into the battery management system, such that when low battery state is reached the "pulsing" of the DC motors is mimicked by the klaxon, re-enforcing the message to the operator to recharge the batteries.
- 4.1.5 DRIVE CONTROL VALVE (DCV):-** The motion control valve comprises several individual components all directly involved in the hydraulic supply to the wheel drive motors. Principal amongst these are the drive control valves, which electrically change the drive motor hydraulics supply from series flow to parallel, or vice versa. This control function is only available when the booms are lowered, and allows the operator to select "Hi" or "Lo" drive. "Hi" drive gives fast speed of travel, but low gradeability, "Lo" drive gives best gradeability, but slow speed. "Lo" drive is used for climbing inclines and delicate positioning of the machine.
- 4.1.6 BRAKE RELEASE VALVE (BRV):-** The motion control valve also incorporates a solenoid operated dump valve, which controls the brake function on the machine. This valve must be energised to allow the machine to move. If no voltage is present, the wheel motors will not be able to develop drive torque, whilst at the same time, the parking brakes will remain engaged. Only when a green "Power Control" push-button is being used (or the Platform Foot-switch is depressed) will the BRV operate. If the tilt alarm sensor detects an excessive inclination whilst the booms are raised it is the BRV which is de-energised to isolate the machine. (At the same time the klaxon tone changes to a continuous tone to indicate this condition).

Operating & Safety Instructions

- 4.1.7 BOOM SWITCH:** - Mounted on the end of the machine counterbalance, and operated by the upper boom, this switch controls both the operation of the tilt alarm sensor, and the speed control function. With the booms in the stowed position, the tilt alarm sensor is by-passed, allowing the machine to negotiate slopes in excess of the permissible working angle, without isolating the drive function. At the same time, "Hi" drive is possible, as is fast throttle on those machines so equipped. When the booms are raised, the tilt alarm sensor becomes activated, only slow speed operation is possible and only "Lo" drive is permitted. These control functions are of primary importance to safety of the machine and operator. Under no circumstances should this control function be isolated or by-passed. Note! On later machines the boom switch is located adjacent to the Knuckle, and works from a cam attached to Boom 3. This permits the operator to slightly raise the Booms whilst still permitting high-speed drive. All other functions remain the same.
- 4.1.8 BATTERY MANAGEMENT:** - Battery condition is permanently monitored by the control circuit, such that when available power has decreased to 80% of full charge, the battery status circuit begins to "chop" the power to the hydraulic power packs. This function causes the drive system to alternately stop and start, signalling to the operator that re-charging is necessary. At the same time the Klaxon will begin to sound intermittently re-enforcing the charge warning. At this point, sufficient power remains to drive to the nearest power point. Should the operator ignore the on-set of the discharge warning, the "chopping" will continue until the machine is rendered inoperative. Immediate charging will then be required.
- Under no circumstances should a machine be left fully discharged or severe battery damage can occur in a relatively short time.
- 4.1.9 BATTERY ISOLATORS:** - The battery-disconnect handles are located beneath the rear bonnet section and allow the machine control and power circuits to be isolated from the batteries. In order to isolate the batteries it is necessary to pull **both** release handles. The left side release handle also incorporates a control circuit connector. Pulling this handle also disconnects the supply to the PCB control box. Under normal operation, the machine key switch should be used to isolate the machine, with the battery isolator handles only being required for emergencies, in the event of a short circuit, or during routine maintenance.
- 4.1.10 DUTY SELECTOR:** - On multiple power option machines, one of the functions on the platform control station will be a duty selector. This key switch allows the selection of either power option, i.e. from Diesel to Battery or Petrol to battery, or vice-versa. On other machines this same key switch serves as an "On-Off" control.
- 4.1.11 DIESEL ENGINE:-** Generally a Kubota OC60 or OC95 engine, driving a twin bodied pump with direct mounted pump dump valves (one per section), and integral relief valve on the rear pump. The arrangement allows two speed operation, fast throttle and automatic relief for ramp climbing.
- 4.1.12 DIESEL BOX:** - Located adjacent to the diesel engine, the diesel box combines all of the functions for dual power operation, (Bi-Energy machines), as well as controlling the diesel engine itself. The relays in this box control starting, high throttle, pump dump, duty selector and the diesel stop timer. There is also an integral thermal trip, which protects the throttle solenoid and other functions.

- 4.1.13 PETROL (GASOLINE) ENGINE:** - Generally a Honda GX 240 engine, driving a single body pump with direct mounted pump dump valve. The engine is also equipped with a throttle solenoid for two-speed operation.
- 4.1.14 PETROL (GASOLINE) BOX:** - Located adjacent to the petrol (gasoline) engine, the petrol (gasoline) box combines all of the functions for dual power operation, as well as controlling the petrol engine itself. The relays in this box control starting, high throttle, pump dump, duty selector and engine stop. here is also an integral thermal trip, which protects the throttle solenoid and other functions.
- 4.1.15 LPG OPERATION:-**On machines equipped for LPG operation (propane) the Honda engine will also have an LPG vaporiser, valve lock and micro-vac switch. The supply and regulation of the propane is governed by the installed gas bottle and regulator. The vapour take-off system requires a vaporiser to convert the liquid gas into an airborne mixture. This is then held by the micro-vac switch and valve lock until the engine turns over, creating a vacuum on the inlet to the engine carburettor. The micro-vac switch then tells the valve lock to open, admitting the gas to the engine. If the engine is halted, the system returns to normal, holding the gas until a re-start is attempted. When running on Petrol, the main tap to the gas bottle should be securely closed, to prevent the engine from trying to run on a mixture of the two fuels. If starting to run on LPG, it should be ensured that all petrol is discharged from the carburettor bowl before changing to LPG, since the engine will not run satisfactorily if any petrol is in the carburettor bowl. When turning on the gas, the bottle tap should be opened gradually so that the liquefied gas does not freeze up the vaporiser on contact. Warming up the engine on petrol first will ensure that the vaporiser is already hot enough to begin the gas conversion. A frozen vaporiser will not allow the machine to run on gas. Machines arranged for vapour take-off do not have a vaporiser, but still have the valve lock and micro-vac switch to control the flow of gas to the engine. The functions of the machine are as described above for the liquid take-off system.
- 4.1.16 CAGE WEIGH SYSTEM CONTROL BOARD (MECHANICAL):** - On machines equipped with the mechanical cage weigh system, the control printed circuit board is usually mounted in the rear of the cage control panel. The function of the operation, the indicator lights and fault conditions are all explained in Section 4.5.5.
- 4.1.17 ENGINE WATER TEMPERATURE:** - On those engines equipped with water-cooling, the high temperature sender is connected to an indicator light in the cage panel. High temperature will illuminate the indicator, but not shut down the engine. If the indicator light illuminates during operation, descend immediately and/or stop the engine.
- 4.1.18 ENGINE OIL PRESSURE:** - On those engines equipped with oil sensors, the low oil pressure sender is connected to an indicator light in the cage panel. Low oil pressure will illuminate the indicator, as would total loss of oil or the engine coming to a stop. If the indicator light illuminates during operation, descend immediately and/or stop the engine. When the cage key is turned to the 'engine' position, the light will illuminate to indicate that the engine is not running. This serves to remind the operator to turn the cage key switch 'Off' when not in use. Turning the key switch to 'Off' will de-energise any control relays that might eventually discharge the batteries.

Operating & Safety Instructions

4.2 GROUND CONTROL OPERATION

4.2.1 GROUND CONTROL STATION

ALWAYS ALLOW THE ENGINE TO WARM UP BEFORE OPERATING.



ALL MODELS

- 1) Ensure all red emergency stops are out.
- 2) Turn key switch at ground control station to ground (i.e. fully down).
- 3) Ensure function selector hand valve is turned to **Ground** position (i.e. fully down).
- 4) Turn duty selector in platform to **BATT** (battery) or **ENG** (engine).
- 5) If **BATT** (Battery) is selected go to step 9), if **ENG** (engine) is selected go to step 6).

DIESEL ENGINE OR BI-ENERGY MODELS

- 6) If **ENG** (engine) is selected go to step 7 for a **COLD ENGINE** or step 8 for a **WARM ENGINE**.
- 7) **COLD ENGINE:** - turn the main engine ignition switch (located beneath the front cover) through ON to GL. This engages the glow plug pre-heat system. Hold for 3-5 seconds then turn key fully to ST (start) position and the engine will fire.
- 8) **WARM ENGINE:** - turn the main engine ignition switch (located beneath the front cover) through ON to ST (start) position and the engine will fire.

PETROL (GASOLINE) ENGINE BI-ENERGY MODELS

- 6) If **ENG** (engine) is selected go to Step 7 for a **COLD ENGINE** or Step 8 for a **WARM ENGINE**.
- 7) **COLD ENGINE:** - turn the engine fuel tap on and engage the choke lever. Turn the main engine ignition through ON to ST (Start) and the engine will fire. Return the choke lever to its normal running position after the engine is started.
- 8) **WARM ENGINE:** - turn the engine fuel tap on and turn the main engine ignition through ON to ST (start) position and the engine will fire.

ALL MODELS

- 9) Push and hold green power button.
- 10) Select function and operate hand levers in full accordance with manufacturers operating and safety manual.
- 11) To return control to platform turn key fully clockwise to up position, and return function selector hand valve to **Platform** position, (i.e. fully up).
- 12) When not in use return machine to stowed position, turn the key to centre off position, remove key and chock wheels.

EMERGENCY PROCEDURES

- 1) Push in red emergency stop to shut down all functions, and select ground control by moving the function selector hand valve to the **Ground** position, (i.e. fully down).
- 2) Operate emergency hand pump (located adjacent to the ground control valve) and manoeuvre the machine on the Ground hand lever controls.

4.2.2 BOOM OPERATION

A) Push and hold green power button.

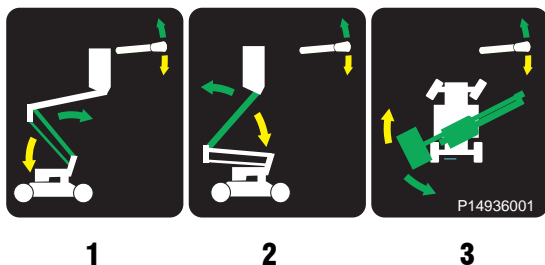

STANDARD HR10 AND HR12 (SP26 & SP34)

B) Select lever 1, 2 or 3 for desired boom function.

1 Operates Lower Boom	UP for up	DOWN for down
2 Operates Upper Boom	UP for up	DOWN for down
3 Operates Swing	UP for right	DOWN for left

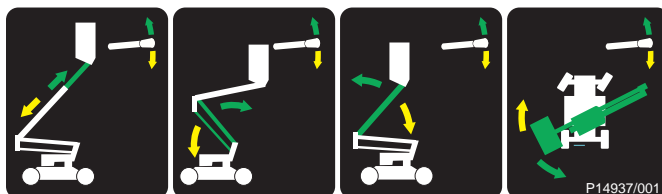

HR12 WITH GROUND TELESCOPE CONTROL (SP34)

C) Select lever 1, 2, 3 or 4 for desired boom function.

1 Operates Telescope	UP for out	DOWN for in
2 Operates Lower Boom	UP for up	DOWN for down
3 Operates Upper Boom	UP for up	DOWN for down
4 Operates Swing	UP for right	DOWN for left



ALWAYS ENSURE THE AERIAL PLATFORM IS ON A FIRM LEVEL SURFACE AND THE AREA IS FREE OF ANY OVERHEAD OBSTRUCTIONS.

ENGAGING THE RED EMERGENCY STOP BUTTON WILL SHUT DOWN THE ENGINE, AND THE ELECTRIC CIRCUIT PREVENTING OPERATION OF ANY FUNCTION.

4.3 PLATFORM CONTROL OPERATION

4.3.1 PLATFORM CONTROL STATION

NEVER START THE NIFTYLIFT IF YOU SMELL PETROL (GASOLINE), LIQUID PROPANE OR DIESEL. THESE FUELS ARE FLAMMABLE.

BEFORE OPERATING THE NIFTYLIFT ENSURE THAT EACH OPERATOR HAS READ AND FULLY UNDERSTOOD THE OPERATING MANUAL. FAILURE TO DO SO MAY RESULT IN DEATH OR SERIOUS INJURY.



ALL MODELS

- 1) Ensure all red emergency stops are out.
- 2) Turn key switch at ground control station to **Platform** position (i.e. fully up).
- 3) Ensure function selector hand valve is turned to **Platform** position, (i.e. fully up)
- 4) Turn duty selector in platform to **BATT** (Battery) or **ENG** (Engine).
- 5) Battery electric models go to step 10.

DIESEL ENGINE OR BI ENERGY MODELS ONLY

- 6) If **ENG** (Engine) is selected go to Step 8 for **COLD ENGINE** or Step 9 for a **WARM ENGINE**.
- 7) **COLD ENGINE:** - Turn the 3 position engine ignition switch to the left, and hold for 3-5 seconds, this engages the glow plug pre-heat system. Then turn key fully to the right and the engine will fire. When released, the selector will return to the centre, '**OFF**' position.
- 8) **WARM ENGINE:** - Turn the 3 position engine ignition switch to the right and the engine will fire. When released, the selector will return to the centre, '**OFF**' position.

PETROL ENGINE OR PETROL/ELECTRIC MODELS ONLY

- 6) If **ENG** (Engine) is selected, ensure the fuel tap is turned to the ON position and then go to Step 8 for **COLD ENGINE** or Step 9 for a **WARM ENGINE**.
- 7) **COLD ENGINE:** - (From the ground only) turn the engine fuel tap on and engage the choke lever. Turn the main engine ignition through ON to ST (Start) and the engine will fire. Return the choke lever to its normal running position after the engine is started.
- 8) **WARM ENGINE:** - Ensure the main engine ignition switch is ON. Turn the 3 position engine ignition switch to the right and the engine will fire. When released, the selector will return to the centre, '**OFF**' position.

ALL MODELS

- 9) Ensure key switch selector is turned to **ON** or **BATT** (Battery) if applicable.
- 10) Depress foot switch or push and hold green power button.
- 11) Select function and operate hand levers in full accordance with manufacturers operating and safety manual.
- 12) When not in use return booms to stowed position. Turn key switch at ground control to centre off position, remove key and chock wheels.

4.3.2 BOOM OPERATION

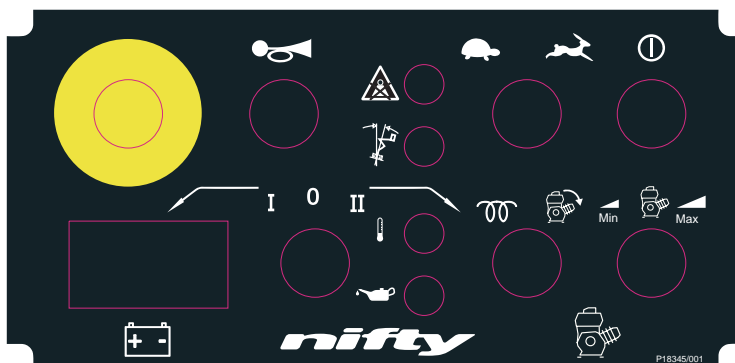

(BI-ENERGY MODEL SHOWN)

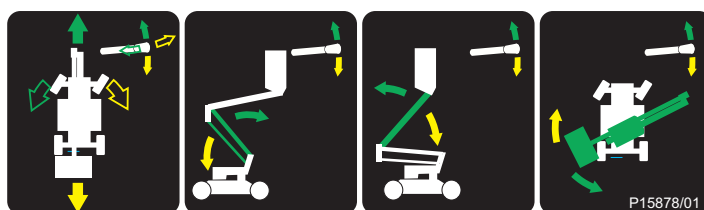

HR10 (SP26) SERIES ONLY

- 1.** **2.** **3.** **4.**

Select lever 1, 2, 3 or 4 for desired boom function.

1. Operates Drive and Steer (see explanation in Section 4.4)		
2. Operates Lower Boom	UP for up	DOWN for down
3. Operates Upper Boom	UP for up	DOWN for down
4. Operates Swing	UP for right	DOWN for left



HR12 (SP34) SERIES ONLY

Select lever 1, 2, 3, 4, 5 or 6 for desired boom function.

1. Operates Drive and Steer (see explanation in Section 4.4)		
2. Operates Platform Level	FWD for fwd	BACK for back
3. Operates Telescope	UP for out	DOWN for in
4. Operates Lower Boom	UP for up	DOWN for down
5. Operates Upper Boom	UP for up	DOWN for down
6. Operates Swing	UP for right	DOWN for left

Operating & Safety Instructions

4.4 DRIVING CONTROLS



DO NOT OPERATE THE NIFTYLIFT WHILST ELEVATED UNLESS ON A FIRM, LEVEL SURFACE FREE FROM ANY POSSIBLE OBSTRUCTIONS OR HAZARDS BOTH AT GROUND LEVEL AND OVERHEAD.

- 1) Check proposed route for possible hazards, obstructions and personnel.
- 2) Push green power button or depress foot switch located in platform floor (if applicable).
- 3) Use the **Drive Speed** selector on the platform control station to determine speed.
High Drive (Hare) - GIVES HIGH SPEED AND LOW GRADEABILITY.
Low Drive (Tortoise) - GIVES LOW SPEED AND HIGH GRADEABILITY.
N.B. High Drive is only available when the booms are in the stowed position. The HR10 or HR12 will default to Low Drive speed whenever the booms are elevated.
- 4) Select drive joystick from the platform control box.
 - A. Up for **FORWARD**
 - B. Down for **REVERSE**
 - C. Left for **STEER LEFT**
 - D. Right for **STEER RIGHT**
- 5) All control levers give a fully proportional response therefore the more the lever is moved away from the centre (OFF) position the faster the function will become.
- 6) Maximum drive speed is only attainable when all booms are fully stowed and the **HI/LO** selector is in the **HI** position.
- 7) When driving with the booms fully stowed, the Tilt Alarm is bypassed to allow the Niftylift to be driven in areas where the slope exceeds the five-degree working limit. In normal operation the drive is therefore unaffected when driven onto a slope in excess of five degrees, until the booms are raised, whereupon the drive would be disabled and the tilt alarm sounds continuously.
- 8) Under no circumstances should any Niftylift SP series machine be driven on slopes exceeding 25%, with the booms fully stowed.



ALL NIFTYLIFTS ARE FITTED WITH A TILT ALARM - PRE-SET IN THE FACTORY. ONCE ENERGISED, THE NIFTYLIFT WILL LOSE ALL POWER TO DRIVE FUNCTIONS AND A LOUD AUDIBLE ALARM WILL BE ACTIVATED.

TO DE-ACTIVATE, LOWER THE BOOMS FULLY TO STOWED POSITION AND RE-POSITION BASE ON FIRM, LEVEL GROUND.

IF ALARM SOUNDS - DESCEND IMMEDIATELY AND RE-LEVEL MACHINE BASE.

4.5 CAGE WEIGH SYSTEM

4.5.1 MECHANICAL VERSION

The Niftylift range of machines are available fitted with mechanical cage weigh systems. These are configured to sense a vertical cage overload, which when detected will halt the machine movement. No further use of the platform is then permitted until the overload has been removed. This must be done in a responsible manner and not one in which a greater hazard might be induced. Therefore, if the addition of external items such as light fittings; brickwork or tiles etc were allowed into the cage, the machine would not operate. In order to restore the functions, the excess load should be safely removed, NOT by discharging them out of the basket to the detriment of persons below.

The mechanical cage weigh system works on the principle of a pre-loaded spring, rated to the cage safe working load. Excess load in the cage forces the spring to further compress, the movement of which is detected by a precision micro-switch. With the machine turned 'On', this movement first gives an audible alarm in the cage, as well as a visual indication at both control positions (cage and base). Additional deflection due to increased load serves to cut off the machine control circuit, effectively halting all machine movements.

Under the circumstances where the cage overload cannot be removed, the machine can only be manoeuvred by use of the emergency hand pump. Great care must be taken when utilising this facility, especially if the machine is significantly overloaded; any motion that causes the machine outreach to increase could induce instability. The machine must be manoeuvred in such a manner as to reduce outreach, then height, until a safe level is reached to permit the operator to dis-mount or the overload to be removed.

4.5.2 FUNCTION

The cage overload system is powered from the machine control circuit, so the system is inactive if the machine is turned 'Off'.

'Enabling' the emergency stops allows the system to become 'active', when either the cage or base key switch is turned 'On'. If the cage is overloaded, the control circuit will immediately indicate this by the audible and visual alarm. Pressing the emergency stop or turning the key switch to the 'Off' position merely silences the alarm. The alarm will continue to sound as long as the overload persists, unless the machine is turned 'Off'.

Whilst the overload is detected, pressing the green button at base or cage will generate no response from the control circuit. The machine will not function under power until the overload is removed. Removing the overload as previously described will re-set the system automatically, requiring no additional intervention from the operator. All machine functions will be restored.

4.5.3 TESTING

At the simplest level, before working on the platform, the function of the cage overload can be checked by the following method: - Place two men into the cage and a larger quantity of tools than is permitted to be carried. (Typically 40 kg). The alarm should sound and all functions should be lost. Reducing the cage contents to the safe working load should silence the alarm and restore the machine operation.

Operating & Safety Instructions

4.5.4 CALIBRATION

If a closer examination of the system is required, typically for testing and approval, the safe working load should be placed in the cage, carefully weighing the test load to ensure accuracy. The addition of a 5kg weight, to any of the four corners of the cage, should sound the alarm. If the alarm does not sound, carefully inspect the weigh mechanism for signs of damage. All parts of the weigh mechanism should be free to move, and the inspection should look for any impact damage that might have caused the assembly to become disabled, for any reason. If the mechanism seems to be functioning correctly, the adjustment of the weigh sensing micro-switch should be checked. A competent person, who has the authority to perform such adjustments, must perform this. Adjustment must not be permitted by anyone without the approval of the person responsible for the platform.

With the machine emergency stops 'enabled' and either the cage or base key switch turned 'On', the cage weigh micro switch is adjusted to bring the bolt into contact with the micro-switch roller. Continue adjustment until the alarm sounds, then back off slightly to silence the alarm. The locknuts supporting the adjustment bolt can be partially tightened to lock the bolt in place.

The addition of a 5 kg weight should now be used to prove that the system detects the applied overload, sounds the alarm and disables the machine. The sensitivity of the assembly is such that the alarm will sound slightly before the functions are disabled. The mechanism should be adjusted to allow the alarm to sound and functions to be lost within this 5 kg limit. Lock the adjustment screw securely.

The over-travel adjusters can now be used to protect the micro-switch from excess forces should a substantial overload be applied to the cage. (Typically if the machine is manoeuvred into contact with a fixed object, snagging the cage assembly, this would be detected as an overload to the system.) Adjust the screws forward until they come into contact with the cage weigh mechanism, then with the cage overload still applied and the alarm sounding, functions disabled and machine not operating, lock them in this position. Care should be taken to not turn the adjuster screws in too far; otherwise the overload signal might be lost.

The machine can then have the overload removed and the functions of the machine checked for correct operation.

4.5.5 INSPECTION

The cage weigh system is controlled through the detection printed circuit board, part number P16164. This PCB is connected directly to a safety micro-switch and monitors the function of the cage weigh system. The two relays are configured such that both need to operate to permit safe operation of the assembly. Should either of them fail, an error signal is generated which can be seen on the printed circuit board itself. This occurs if pressing the green button does not allow the machine to operate, no overload signal to be given, with no load in the cage. In this case, open the cage pushbutton box or separate box containing the PCB and look at the printed circuit board.

There are three LED's (Light Emitting Diodes) on the board, Red LD1 for 'Overload', Red LD2 for 'Relay 1/2 failed' and Green LD3 for 'Machine enable'. The first indicates the overload when the machine is turned 'On', the second indicates a relay failure when the green button is pressed, and the third shows the machine is enabled, again when the green button is pressed.

The failure signal is generated if either relay fails to respond to the 'safe' cage weigh signal from the safety micro-switch, either due to a coil or contacts failing or if a contact sticks in place due to welding. Under either circumstance the 'enable' signal is blocked, instead generating the error message, illuminating the red LD2. The machine will not operate under this situation. The red error signal from LD2 requires the board to be changed, as the relays are not serviceable items.

4.5.6 MAINTENANCE

The cage weigh mechanism is supported on maintenance-free precision needle roller bearings for smooth running and friction-free operation. The accuracy of the entire assembly and in particular the hysteresis is dependent on these components. Keeping them free of dust and dirt is recommended; and an occasional application of WD40 to the external faces should keep them mobile and deny the entry of dust and moisture.

The hysteresis is the amount of load required to be removed before the system re-sets allowing continued operation.

If the assembly is subjected to any external impact force, typically whilst manoeuvring the machine under power, or in the case of trailer units, whilst being reversed into position, the cage assembly will require close inspection. If there is evidence of any deformation in any part of the structure, then the advice of a Niftylift Service technician should be sought. Physical damage to the assembly is liable to render the cage weigh system inactive, or to affect the accuracy of the result. Under no circumstance permit a damaged machine to enter service without performing a thorough inspection and calibration of the weigh assembly.

For this reason it is not recommended to restrain the machine in transit using strap or chains passed through or over the cage itself. This is particularly true of the electronic load cell system, which could be permanently damaged by the application of such excessive external forces. Whilst the mechanical system could be considered to be more robust in operation, the same restraint forces that could be generated through ratchet straps and the like, is likely to cause some severe deformation in the lightweight cage structure. Use only the designated tie-down points on your Niftylift when strapping the machine down for transport. Failure to observe this instruction could render the machine unusable, and a considerable repair bill for the damaged components.

4.5.7 REPLACEMENT

If components are replaced, they must be genuine Niftylift parts. The accuracy and function of the cage weigh system relies on the like-for-like application of the component parts. A switch from a similar manufacturer might reverse the contact arrangement and critically affect the function of the mechanism. Similarly, the accuracy of the sensing circuit relies on the duplication of the contact travel within the switch itself. Using a non-equivalent component will render the cage weigh system inactive. Under no circumstances should you permit a machine with a defective cage weigh assembly to enter service.

If in doubt about the operation or function of your machine, always request the circuit diagram that goes with the machine serial number. Look at the bottom of the machine serial plate; one of the final two numbers stamped there will give the electrical circuit for the machine. ('D80000' number, plus the issue status immediately afterwards: - /01;/02;/03; etc, see Section 1.5 & 1.5a)

If in doubt, contact the Niftylift Service Department on (44) 01908 223456, Fax: 01908 227460.

4.6 BATTERIES AND CHARGING



BATTERIES MUST BE RECHARGED IN A WELL-VENTILATED AREA FREE OF FLAME, SPARKS OR OTHER HAZARDS THAT MAY CAUSE EXPLOSION. HIGHLY EXPLOSIVE HYDROGEN GAS IS PRODUCED DURING THE CHARGING PROCESS.

- 1) Recharge batteries at the end of every working day or shift.
(**Note:** To recharge batteries fully from flat takes approx. 12 Hours, this consists of 8 hours bulk charging plus 4 hours equalisation).
- 2) Plug charger into suitable power supply, either 240 volts or 110 volts AC (see **Charging Limitations**). (Note: If using 240V, use of a suitably rated Earth Leakage Circuit Breaker (ELCB) or Residual Current Device (RCD) at the point of supply is highly recommended.)
- 3) Take note of the indicators provided:

Red Light - Batteries are charging.

Pulsing Green light - the charge is equalising.

Constant Green light and pulsing Red light - the batteries are fully charged.



UNDER NO CIRCUMSTANCES SHOULD BATTERIES BE LEFT ON CHARGE FOR PERIODS IN EXCESS OF 24 HOURS

- 4) **DISCONNECT FROM POWER SUPPLY ONCE BATTERIES ARE FULLY CHARGED.** The machine can now be left unattended, however, in the event of the machine being left unused for extensive periods then a **4 to 6 hour** 'top-up' charge every **4 weeks** is recommended. A 'top-up' charge the day before use ensures a full day of operation from the machine.



UNDER NO CIRCUMSTANCES SHOULD A MACHINE BE LEFT FULLY DISCHARGED AS SEVERE BATTERY DAMAGE CAN OCCUR IN A RELATIVELY SHORT TIME.

- 5) To avoid damage to charger disconnect from mains supply before using machine.

Note:

- 1) If the charger is reconnected to the power supply shortly after it has gone through its full charging cycle the Red LED may come on although the batteries may be fully charged. The charger would then go through its complete cycle again at an accelerated rate, depending on the time difference between connection, reconnection and level of battery charge.

- 2) Some Niftylifts are fitted with a Battery Management System, which permanently monitors the condition of the batteries. When the batteries become discharged to 80% of their capacity the management system will begin to "shut down" the hydraulic power packs. This causes the drive/boom operating system to alternately stop and start, signalling to the operator that re-charging is necessary. However, there is sufficient power remaining to enable the operator to drive slowly to the nearest charging point.

Should the operator ignore the onset of the battery discharge warning the "shut down" of the motors will continue, until the machine is rendered in-operative. **Immediate charging will then be required.**

CHARGING LIMITATIONS

Battery charging times will increase slightly if using an 110V supply as opposed to a 240V supply. This is due to the connection of the primary coils being in parallel, which in effect only allows the transformer to see 220V. Similarly, the capacity of the 110V supply will decide the input current available; hence a small hand-tool transformer will not operate the battery charger efficiently, therefore:

- charging times will increase further due to input limitations.

Attention should also be given to the use of extension cables as power leads. Excessive cable lengths from the supply point to the battery charger will result in significant voltage drop, leading to a reduction in the chargers efficiency. In addition, inadequate sized cable cores will have a limiting effect on its current carrying capacity, which will again lead to a reduction in the chargers efficiency. Both of these can result in over-heating of the cable with the attendant risk of fire, short circuits or damage to the components themselves.

The charger requires a minimum battery voltage of 4.5 volts per battery (overall for two batteries 9 volts, for 4 batteries 19 volts for 8 batteries 38 volts). If the voltage is below these values then the charger will not function (Charger will not detect batteries to begin charge.) If the batteries have fallen to such a poor state they will have to be removed from the machine and charged individually with an independent charger until the optimum voltage has been reached. This is best performed at very low currents to 'recover' the batteries if sulphation has already started i.e. a 'trickle' charger. This can take several hours, possibly days. Careful monitoring of the rise of battery voltage will indicate when recovery has been achieved.

TOPPING UP

During the course of normal operation, the batteries should be inspected at least once a fortnight to check the level of electrolyte. During the end of charge, gassing takes place, which will cause a slight reduction in the volume of acid in the battery. This can be topped up with de-ionised water as required. During this inspection, it is useful to note any imbalance in the fluid levels. One indication of a faulty cell would be an increase in the loss of battery acid, which would then require more frequent topping up on that cell, or cells. Faulty cells can liberate excess hydrogen, even during normal operation, with the resulting risk of explosion if ignited. **Any faulty batteries should be replaced as soon as possible with an equivalent sized and rated unit.**

Note: Protective safety glasses and gloves (Appropriate PPE) MUST be worn whilst performing these checks.

Operating & Safety Instructions

4.7 TRANSPORTING, TOWING, CRANEAGE, STORAGE AND SETTING TO WORK

4.7.1 TRANSPORTING

If a work platform is to be moved over a longer distance, whether the machine is trailer mounted, vehicle mounted, self propelled or tracked, the following procedure should be read before restraints are attached to the machine. Cross loading is most frequently the cause of problems, as the method of loading is no longer in sight of our own personnel. The recommendations made herein should be passed on to subsequent carriers, such that the entire journey is carried out without incident.

- Always ensure the truck or trailer you are loading or towing the Niftylift with can carry it legally.
- If loading by crane the use of shackles and an adequately rated spreader beam, with four leg slings, is **MANDATORY**.
- When loading or un-loading from the side of the vehicle, the use of the forklift pockets to retain one of the forks is recommended. (If fitted). Spread the forks to their widest capacity, with due regard to the components fitted to the machine. Never forklift or crane an entire machine under the booms, always lift beneath the spine or under the ends of the axle mountings in the case of a self-propelled unit. Ensure forklift is adequately rated for the load to be carried.
- Once positioned on the transport carrier ratchet straps should be used to secure the machine. The machine should be positioned to allow easy access around the machine in transit, and to ensure that 'creepage' during transport does not permit the machine to come into contact with other goods being shipped, or the container itself. Some movement of the machine structure might occur during transit, which could lead to fretting or other damage.
- If the machine is equipped with a transit device such as a boom clamp etc, this should be securely applied.
- Strap booms carefully to constrain them from sideways movement. When using straps or chains, adequate packing should be applied to stop any damage to the structure and paintwork. Due regard of the movement of the straps or chains must be taken into account.
- Where a machine has designated points for strapping, lifting or forking, these can be used for tie-down duty. When they are absent, the major structure of the platform can be used, giving due consideration to the design and function of the area chosen. Where possible, use the spine of the machine or axle mounts over which to apply the holding down forces. Using a single plate, such as an outrigger or stabiliser support plate might be unsuitable. If the component was clearly not designed to accommodate a side load, one should not be applied.
- Under no circumstances should straps or chains be applied over booms or through the cage support structure or the cage itself. The relative strength of the carrying structure is not conducive to the massive forces capable of being applied through ratchet chains or slings. Severe damage to the steelwork can be caused, as well as deformation to sensitive mechanisms such as cage weigh assemblies, which would render them useless. Such catastrophic damage to say, an electronic load cell would require the component to be replaced before the machine would function.

4.7.2 TOWING - Hydraulic Drive motors and spring applied Brakes.

For towing the Niftylift in case of an emergency.

- 1) If parked on a slope securely chock all wheels.
- 2) Remove rear cover: locate brake release valve and turn anti-clockwise. The rear wheel motors are now free of the hydraulic circuit.
- 3) Remove middle cover: locate brake release lever and remove both springs. The front wheel hub brakes are now released.
- 4) The Niftylift can now be towed over short distances - maximum speed 5mph.



REMEMBER TO REPLACE SPRINGS AND RETURN HAND VALVE TO ORIGINAL POSITION BEFORE OPERATING THE NIFTYLIFT.

FAILURE TO DO SO WILL LEAVE THE MACHINE WITH NO HYDROSTATIC OR PARKING BRAKES AND NO DRIVE POWER.

Note! On later machines, un-braked steer hubs replace the front brake hubs and the drive motors have integrally braked gearboxes. In order to tow the machine the following procedure is required;

TOWING - Gearbox Drive motors with integral hydrostatic brakes. (Not spring applied.)

For towing the Niftylift in case of an emergency.

- 1) If parked on a slope securely chock all wheels.
- 2) Remove rear cover: locate brake release valve and turn anti-clockwise. The rear wheel motors are now free of the hydraulic circuit.
- 3) From within the ground control panel, move the brake override lever to the horizontal position. Fit the emergency hand pump handle and give the hand pump several pumps until pressure is felt to build. A visual check of the brake telltale (Located next to the Drive Control Valve) will indicate when the brakes are released. When the indicator knob comes out of the block, the brakes are 'Off'.
- 4) The Niftylift can now be towed over short distances - maximum speed 5mph.
- 5) To re-set the brakes, move the brake override lever back to the normal 'up-right' position. The telltale indicator will return flush into the block. It might be necessary to cycle the lever more than once to re-set the brakes.
- 6) In order to drive the machine once more, the brake release valve will need to be closed, by turning clockwise. The wheel motors are now re-connected to the hydraulic circuit.
- 7) If the brake override lever is not re-set manually, the next time the machine is moved hydraulically, the brakes will automatically re-set themselves. The brake override lever will however be in the wrong position for emergency operation of the booms, and should be returned to the normal 'up-right' position as soon as possible.

Operating & Safety Instructions

HR12 4x4 Only - Brake override and towing

For towing the HR12 4x4 in case of an emergency.

- 1) If parked on a slope securely chock all wheels.
- 2) Ensure the 'brake release tap' is fully closed, i.e. wound clockwise.
- 3) Locate hand pump handle onto hand pump and pump several times until the brake 'telltale' pops out from the side of the 'drive control valve block'. The brakes are now hydraulically released.
- 4) Open the bypass circuit by turning the red knob on the 'drive control valve block' a couple of turns anti-clockwise. The motors are now free to turn.



NOTE – THE MACHINE IS NO LONGER RESTRAINED FROM RUNNING AWAY AND MUST BE POSITIVELY HELD BY SOME OTHER MEANS (SEE ABOVE).

- 5) The machine can now be towed a short distance with the oil re-circulating around the drive circuit.

Re-setting the drive system

- 1) Before the machine will drive again, the red knob on the 'drive control valve block' must be wound fully shut (clockwise until tight). Failure to do so will render the drive function inoperative.
- 2) To restore the brake function, turn the 'brake release tap' a couple of turns anti-clockwise. When the 'telltale' in the side of the 'drive control valve block' pops back in, the brakes are now holding.
- 3) Wind the 'brake release tap' fully closed i.e. clockwise until tight. The machine is now ready to drive, brake and hold on a slope.
- 4) Once the 'drive control valve block' red knob has been fully closed, driving the machine forwards or backwards will also automatically re-set the brake circuit.
- 5) Remove the hand pump handle and replace in the clips.

4.7.3 CRANEAGE

- 1) Observe all of the limitations relating to straps and chains stated above under 'Transporting'. (4.7.1)
- 2) When utilising the designated lifting points never apply a 'snatch' load, i.e. lift slowly to take up the load before raising. Similarly, do not drop machine when positioning after lifting.
- 3) If the machine is to be lifted by crane, use the designated lifting points and observe the recommendations regarding spreader beams. Individual drawings are available for each machine type, on request. (See list below.)

D80461	HR10/12
D80935	HR15N
D80936	HR15 4x4
D81301	HR17N
D80937	HR17 4x4
D80938	HR21

4.7.4 STORAGE

If being stored for any length of time without use, then the machine should be thoroughly inspected for the following:-

- 1) Grease all bearings /slides, worm drives, etc.
- 2) Check batteries for electrolyte levels, state of charge, damage, dirt, etc. Never leave in a state of discharge for any length of time. If no use of the platform is intended, an occasional "top-up" charge of the batteries will serve to equalise their charge level.
- 3) Leave battery disconnect switch in OFF position to prevent discharge of batteries through leakage.
- 4) If machine is to be left on an incline, chock wheels to prevent creep.
- 5) If machine is to be left outside or in a hostile environment, cover with suitable weatherproof media to prevent deterioration.

4.7.5 SETTING TO WORK

Before use each day and at the beginning of each shift the machine shall be given a visual and functional test including, but not limited to, the following

- 1) Check all lubrication points for adequate application of grease, oil etc.
- 2) Inspect all threads for ease of operation - especially descent valves, brake release valve etc.
- 3) Check level and quantity of oil. Remove any contaminants - water, etc.
- 4) Check batteries for electrolyte and state of charge.
- 5) Check electrics for damage and insulation.
- 6) Using ground controls, cycle machine over complete envelope in accordance with the Operating Instructions. Cure any defects.

Operating & Safety Instructions

- 7) Ensure that all safety devices and controls operate in accordance with the instructions.
- 8) If necessary, perform a load test to establish the machine stability before putting the machine to work.
- 9) On completion of an extended period of road transport, the machine might need additional inspection to identify any transit degradation, which could render the machine unsafe. Perform a P.D.I. inspection on the unit before it enters service. Record any faults found and rectify them immediately.
- 10) If left un-attended for an extended period, it is likely that the hydraulic cage levelling will become un-pressurised. Normal operation is then lost, with a noticeable delay in the forwards or backwards motion as the booms move. To restore normal function, the cage needs to be fully levelled forwards and backwards, using the cage-levelling lever whilst **not** standing in the cage (i.e. with the operator standing adjacent to the cage side whilst simultaneously operating the lever and green button to move the cage). Take care not to become trapped between the moving cage and a fixed object, and ensure those around you are clear of the moving cage. When the system has been charged in both directions, the cage levelling function should be restored. If the system operates but is 'jerky' in either direction, this indicates air in the system. Repeat the procedure as described above until the movements are smooth and un-interrupted. If in doubt, contact our Service Department for further advice.

Niftylift Limited is not liable for any third party damage caused during transport. Careful attention to correct procedures will prevent many of the small snags that can happen in transit. Re-work is both expensive and time consuming. A defective machine arriving at the place of work is a poor advertisement for our product, the company's reputation and those of our dealers and clients. The responsibility for safe and damage-free transport rests with the haulier or his representatives.

5 Emergency Controls

5.1 GENERAL

CHECKING THE OPERATION OF THE EMERGENCY CONTROLS EVERY DAY AND/OR BEFORE EACH SHIFT IS AN ESSENTIAL PART OF THE OPERATOR'S DUTIES



The operator and all ground personnel must be thoroughly familiar with the location and operation of the emergency controls.

5.2 IN THE EVENT OF AN INCAPACITATED OPERATOR.

Turn the key switch at the ground control station to **Ground** (Anti-clockwise). Ensure function selector hand valve is turned to **Ground** position (i.e. fully down). Manoeuvre the machine using the ground controls as described previously in Section 4.2.

5.3 IN THE EVENT OF MACHINE FAILURE.

If all machine power is lost, the **Emergency Hand pump** can be used to provide the hydraulic power to manoeuvre the machine. Operating the Emergency Hand pump provides flow to the valve block selected at the ground controls. Hence the ground person can give hand pump flow to enable the **Platform** operator to move the machine, or control can be taken at the **Base** as described above, to enable the ground operator to pump and at the same time, manoeuvre the machine using the Ground hand levers.

Note: If the machine is fitted with a cage overload system, and the cage comes into contact with a fixed object whilst operating at height, this would be detected as an overload condition. All power to the machine controls would be lost, requiring the machine to be recovered using the **Emergency Hand Pump**. It is sufficient for the cage to be manoeuvred away from the collision point to re-set the cage weigh mechanism, thereby restoring normal machine operation. The cage could then be brought down using the controls as described previously.

FOLLOWING AN EMERGENCY DESCENT RECOVERY OF THE PLATFORM, FULLY EXTEND AND RETRACT ALL CYLINDERS FROM GROUND CONTROL STATION BEFORE USING THE MACHINE.



5.4 INCIDENT NOTIFICATION

It is a mandatory requirement that any accident or incident involving a Niftylift, regardless of whether any party received injury or property was damaged is reported by telephone directly to Niftylift. Failure to do so may render any warranty on the machine void.

6 Responsibilities

6.1 CHANGES IN OWNERSHIP

When a change of ownership of a Niftylift occurs, it shall be the responsibility of the seller to notify Niftylift direct of the unit, model and serial number and the name and address of the new owner within 60 days. This important step is required so that all future Technical Bulletins are able to reach the registered owner of each machine without delay. Please note warranties are not transferable.

6.2 MANUAL OF RESPONSIBILITIES

You are required by ANSI/SIA 92.2 1990, to read and understand your responsibilities before you use or operate this aerial platform.

Please read the enclosed document, as failure to do so could result in death or serious injury.

Wherever any contradiction may appear, the Manual of Responsibilities shall take precedence over all other documents.

6.3 Inspection/Service/Pre-Hire Check list

MACHINE SERIAL NO _____

TOWING	PASS	FAIL	N/A
Machine secured on trailer			
Straps correctly positioned and tightened			
Wheels chocked if necessary			
AXLES, WHEELS AND BRAKES			
Wheels are secure, tyre condition acceptable			
Wheel bearings O.K.			
Brake linkages and cables secure			
Brake shoe wear not excessive			
Machine climbs slope			
Brakes hold machine on slope			
Rear hub nut secure			
Track rod secure, not fouling axle plate			
BASE			
Operation of ground control valve and buttons			
Operation of all booms over full range			
Wheel bearings OK			
Cylinders are silent			
Platform is level over full range			
Booms, levelling rods not damaged or distorted			
Booms levelling rods, cylinders not fouling			
Hoses not tight, kinked or fouled			
Operation of emergency hand pump			
SLEWING			
Slew assembly and motor are secure			
Worm/wheel mesh correct, no excessive wear			
No end float of worm in housing			
Slew wheel bolts secure			
Slew guards secure			
PLATFORM			
Operation of control valve and buttons			
Levelling lock valve holds in both directions, lines vented			
Operation of all booms over full range			
Cylinders are silent			
Platform levelling over full range			
Slewing smooth over full range			
Operation of boom 4 over full range (if fitted)			
No excessive movement of boom 4 and boom 3			

nifty Height Rider/SP Series

Operating & Safety Instructions

TILT ALARM	PASS	FAIL	N/A
Booms raised on slope - drive disabled, siren tone constant			
Boom operation unaffected			
Booms lowered - drive restored			
INTERNAL (POWER PACK)			
Power pack and all components secure			
All cables and terminals secure			
All hose connections secure			
Hoses not kinked or fouled			
Charger/control box secure			
Batteries secure			
Electrolyte level and specific gravity			
Charger operation			
Hydraulic oil level			
Engine/Gear box oil			
FINISH			
Pivot pin tag bolts			
Correct decals, all visible			
Canopy/bonnets			
Grease nipples (Feet, Knuckle, Centre Post)			
LEAK CHECK			
Cylinders (Lift, Jacks, Telescope, Levelling)			
Control valves			
Check valves			
Power pack/pump			
Slew motor			
Hose connections			
Filter			
Wheel motors			

Comments, remedial work required etc;

INSPECTED BY: _____ **DATE:** / / **0**